



















LOX5

HÄFELE

LED 2047

833.72.610	833.72.622	833.72.641
833.72.611	833.72.630	833.72.642
833.72.612	833.72.631	833.72.650
833.72.620	833.72.632	833.72.651
833.72.621	833.72.640	833.72.652

12 V System	K	W	T _A	
833.72.610  833.72.620  833.72.630  833.72.640  833.72.650 	3000	3.0 W	-20 °C – +45 °C -4 °F – +113 °F	Ø65x12
833.72.611  833.72.621  833.72.631  833.72.641  833.72.651 	4000			
833.72.612  833.72.622  833.72.632  833.72.642  833.72.652 	5000			

732.28.523

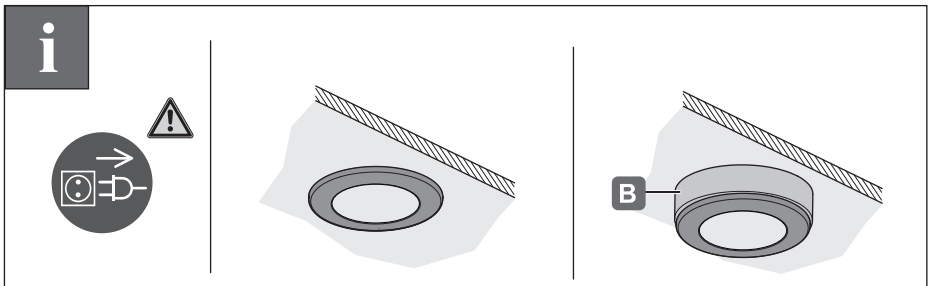
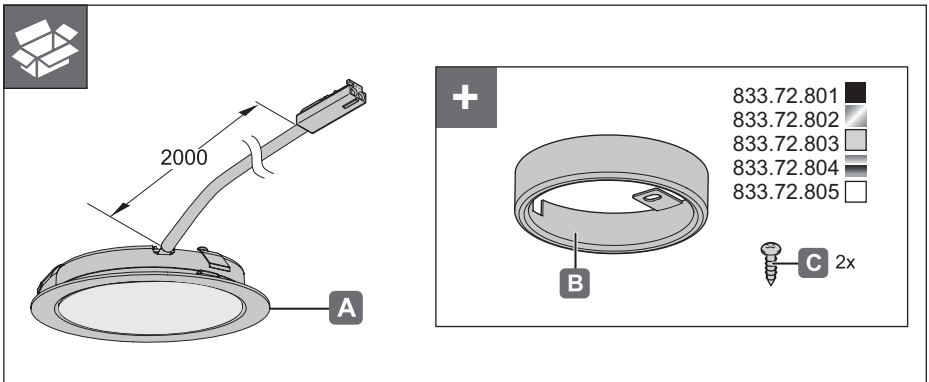

HDE 02.03.2022

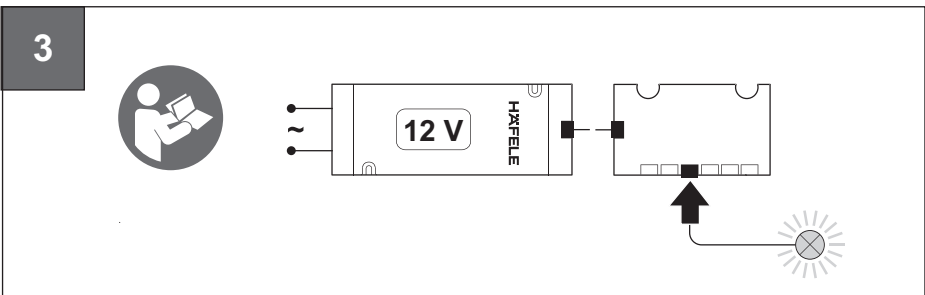
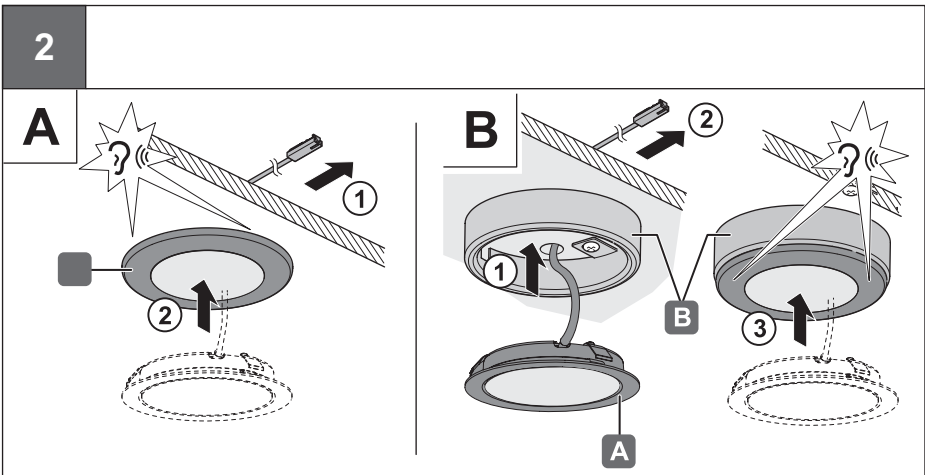
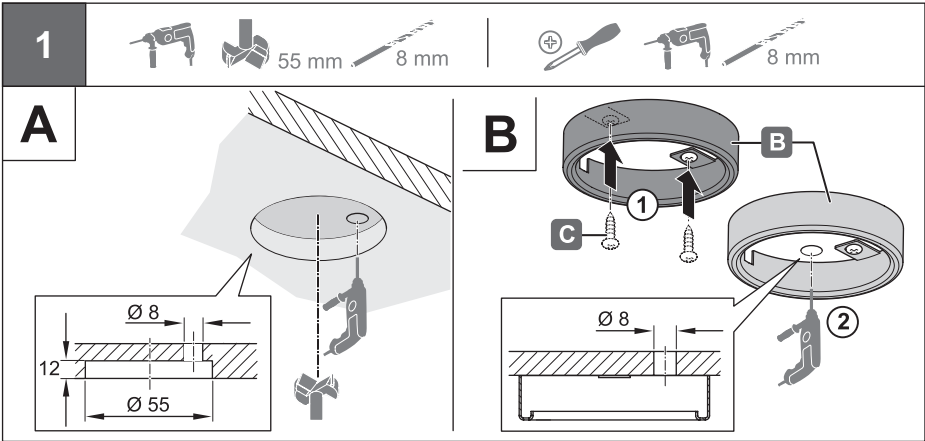

732-28-523

HDE 02.03.2022